



# Self-Clinching Low-Profile Panel Fastener

## Series LPH



LPH panel fasteners are preassembled for attachment to removable sheet metal panels. Screw assemblies remain captive for servicing ease and provide low profile when secure. Slotted head with deep skirt allows tool or finger operation.

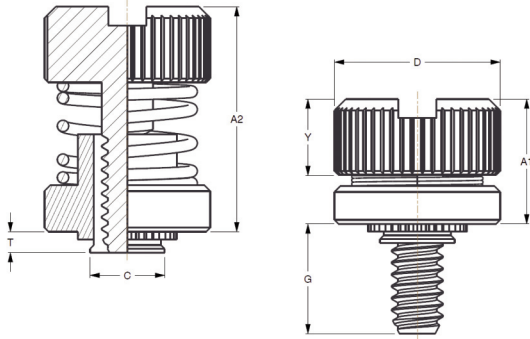

Series	Material	Finish*
LPH	Carbon Steel	Bright Nickel over Copper Flash

\*Black Nitride (BN) finish available

Thread: External 2A, ANSI B.1.1 (6g ANSI/ASME B1.13M).\*\*  
Use in: Materials with Rockwell Hardness of B-60 or less.

Part Number Structure:

LPH-0 440-30

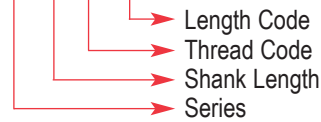

\*\*See Note 3 on Page 6 for Gauging Spec.

### Dimensions & Specifications

	Thread Size	Type	Thread Code	Screw Length Code	Min.	T Max.	G ±.015	C Max.	D ±.010	Y ±.005	A1 Max.	A2 Nom.	+0.003 -0.000	Min.
INCH (in.)	#4-40	LPH-0	440	30	.030	.030	.300	.202	.406	.202	.325	.595	.203	.26
		LPH-1			.040	.038								
		LPH-2			.060	.058								
	#6-32	LPH-0	632	30	.030	.030	.300	.218	.438	.202	.325	.595	.219	.28
		LPH-1			.040	.038								
		LPH-2			.060	.058								
	#8-32	LPH-0	832	30	.030	.030	.300	.249	.468	.207	.330	.600	.250	.29
		LPH-1			.040	.038								
		LPH-2			.060	.058								
	#10-32	LPH-0	1032	30	.030	.030	.300	.311	.530	.220	.335	.605	.312	.33
		LPH-1			.040	.038								
		LPH-2			.060	.058								
1/4-20	LPH-2	420	35	.060	.058	.350	.374	.625	.242	.385	.675	.375	.38	
METRIC (mm)	M3 x 0.5	LPH-0	M3	30	.76	.76	7.62	5.48	10.31	5.13	8.26	15.11	5.5	6.6
		LPH-1			1	.97								
		LPH-2			1.5	1.48								
	M4 x 0.7	LPH-0	M4	30	.76	.76	7.62	6.38	11.89	5.26	8.38	15.24	6.4	7.37
		LPH-1			1	.97								
		LPH-2			1.5	1.48								
	M5 x 0.8	LPH-0	M5	30	.76	.76	7.62	7.98	13.46	5.59	8.51	15.37	8	8.38
		LPH-1			1	.97								
		LPH-2			1.5	1.48								
	M6 x 1	LPH-2	M6	35	1.5	1.48	8.89	9.48	15.88	6.12	9.78	17.15	9.5	9.65

Continued on next page.







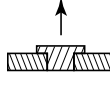

# Self-Clinching Low-Profile Panel Fastener

## Series LPH

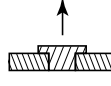

Continued from previous page.

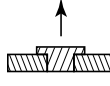
<b>Installation &amp; Performance Data</b>						
Type	Thread Code	Sheet Material				
		5052-H34 Aluminum		Cold-rolled Steel (B-60 Max)		
		 Installation Force (lbs.)	 Pushout (lbs.)	 Installaion Force (lbs.)	 Pushout (lbs.)	
INCH (in.)	LPH-0	440	2200	64	5000	90
	LPH-1			105		110
	LPH-2			185		300
	LPH-0	632	2400	66	5500	90
	LPH-1			105		130
	LPH-2			190		300
	LPH-0	832	2800	68	6000	90
	LPH-1			110		130
	LPH-2			200		300
	LPH-0	1032	3500	72	8000	95
	LPH-1			150		160
	LPH-2			260		425
LPH-2	420	4300	320	12000	450	

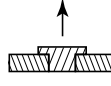
<b>Installation &amp; Performance Data</b>						
Type	Thread Code	Sheet Material				
		5052-H34 Aluminum		Cold-rolled Steel (B-60 Max)		
		 Installation Force (kN)	 Pushout (N)	 Installaion Force (kN)	 Pushout (N)	
METRIC (mm)	LPH-0	M3	9.8	285	22.2	400
	LPH-1			465		489
	LPH-2			823		1334
	LPH-0	M4	12.5	302	26.7	400
	LPH-1			489		578
	LPH-2			890		1334
	LPH-0	M5	15.6	320	35.6	423
	LPH-1			667		712
	LPH-2			1156		1890
	LPH-2	M6	19.1	1423	53.4	2002